

SECTION A-A

DETAIL B
SCALE 1 : 5

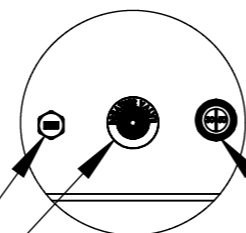

PRV Option Gore Membrane Vent PRV Option AGM Breather Valve PRV Option Humidity Indicator

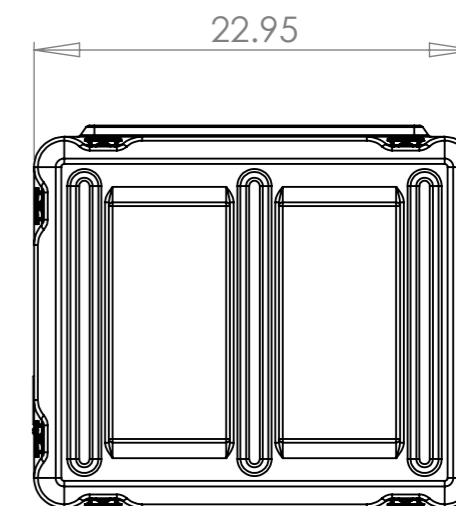
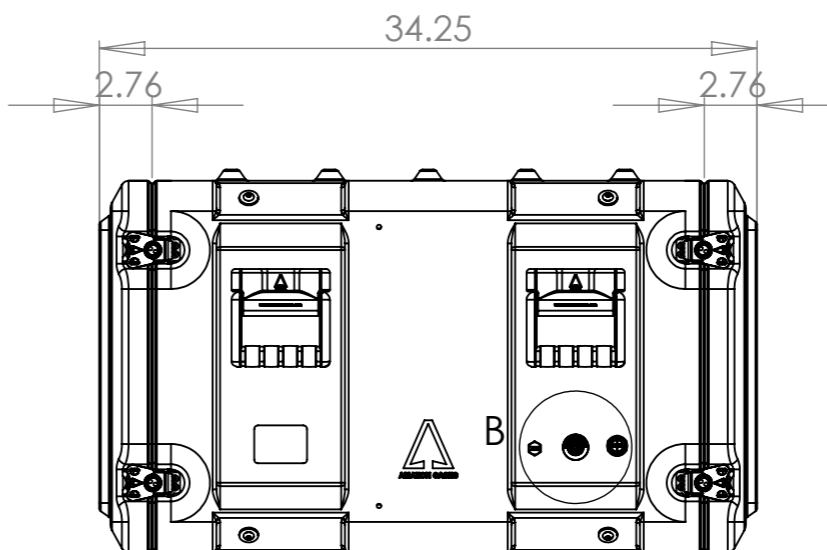
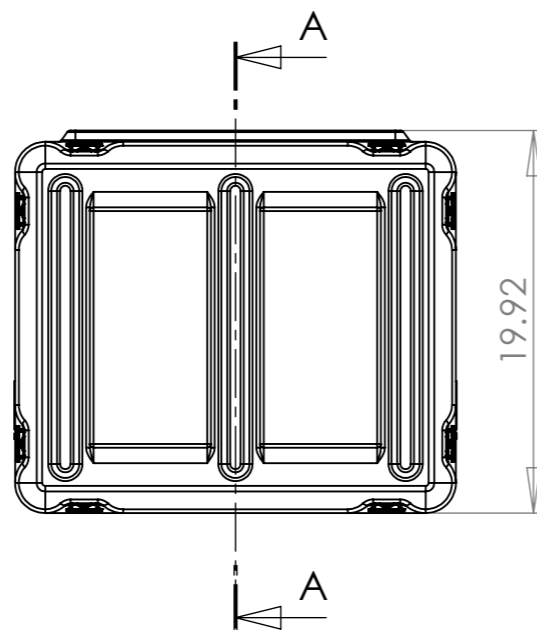
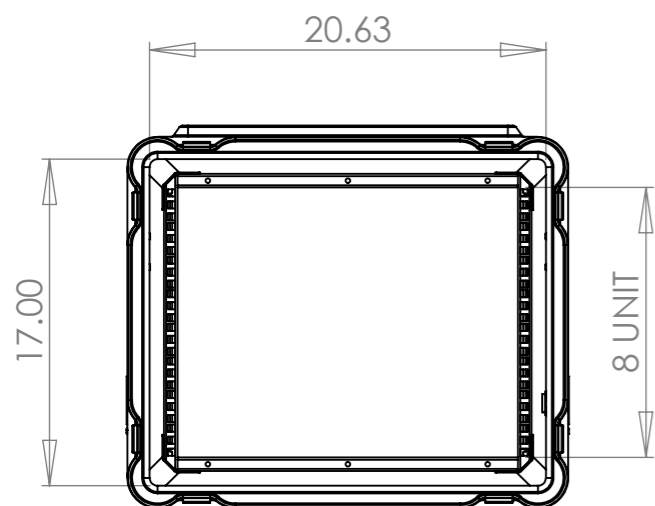
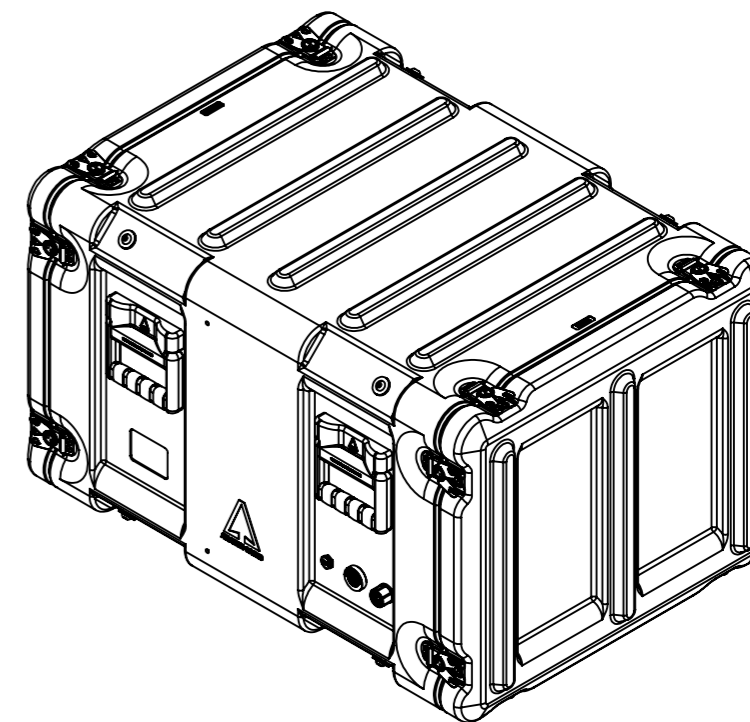

Options Available	Option Selected	Qty	Part #
Wheel Kit <small>includes two extra handles</small>	N	00	AAW002
AGM Breather Valve	Y	01	AAPRV
Gore Membrane Vent	Y	01	AAGTV
Humidity Indicator	Y	01	AAHI
Tie Down Anchor	N	00	AATD001
Padlockable Latch	N	00	AALPLBK
Linking Straps	N	00	AASSBLRS
Cable Stowage Pouch	N	00	AASP****
Easy-Glide	N	00	AAEGS**
Support Shelf	N	00	AASS**
Latch	Y	16	AALBK
Plastic Handles	Y	04	AAHPL

Moulding Tolerance +/- (1%+1/16")		
External Dimensions (Inches)		
Height	Width	Depth
20.0	23.0	34.3
Rack Size (U)		08
Frame Depth (Inches)		24.0

Title				Drg. No.	
Amazon Rack AR0824-0303				AR0824-0303	
Drawn By	Date	Sheet No.	Issue No.		
MW	02/06/2010	1 Of 1	1		
Dimensions In Inches		Third Angle Projection			
Do Not Scale					

CP Cases Inc.

25 Estate Drive, Toronto,
Ontario, Canada, M1H 2Z2.
Tel: (416) 438 8803 Fax: (416) 438 8849
Email: infocanada@cpcases.com Website: www.cpcases.com

Copyright CP Cases Inc.
This drawing is the property of CP Cases Inc & the information on it is confidential & it is not to be used for any other purpose without the prior written consent of CP Cases Inc.